

altronic GTI Bi-Fuel™

OPERATING MANUAL

GTI V-ENGINE CONTROL SYSTEM

FORM GPN2010 OM 4-10



WARNING:

DEVIATION FROM THESE INSTRUCTIONS MAY LEAD TO IMPROPER ENGINE/MACHINE OPERATION WHICH COULD CAUSE PERSONAL INJURY TO OPERATORS OR OTHER NEARBY PERSONNEL.

1.0 OVERVIEW

- 1.1** This manual applies to GTI panels GPN2010V, GPN2212V, GPN2213V, and GPN2214V. For help locating subjects in this document **SEE PAGE 29**.

PANEL CONFIGURATIONS:

GPN2010V	DE-3010 Display and Terminal Board (691172-1), 16 x 14 x 8 enclosure
GPN2212V	DE-3010 Display, Terminal Board (691172-1) and Stepper Motor Controller (691156-1), 18 x 16 x 10 enclosure
GPN2213V	DE-3010 Display, Terminal Board (691172-1), Temperature Monitoring Terminal Board (691172-2), 18 x 16 x 10 enclosure
GPN2214V	DE-3010 Display, Terminal Board (691172-1), Temperature Monitoring Terminal Board (691172-2), Stepper Motor Controller (691156-1), 18 x 16 x 10 enclosure

- 1.2** The control system panel consists of two main parts packaged in an industrial enclosure: Display Module **DE-3010** and Terminal Module **691172-1**. Interconnecting cable **693115-1** connects Module **DE-3010** to Module **691172-1**. An extra Temperature Monitoring Module **691172-2** may also be connected. If the optional Dynamic Gas Control System (**DGCS**) is used, an additional panel **GPN0900** will be included.
- 1.3** The Altronic **DE-3010** controller system is a dedicated electronic microprocessor-based system designed to sense specific analog and digital input points to control and monitor the **GTI BI-FUEL®** natural gas fumigation system for diesel engines. The system is configurable for various applications using a PC (personal computer) and the supplied **DE-3010** terminal program and contains a non-volatile memory to store the setup. Serial communications provide an interface to PC's, PLC's, modems and satellite uplinks for remote communication if desired. A backlit 4x20 LCD character display shows system status, programmed controller parameters and channel labels. A front mounted keypad serves as the user interface. The **DE-3010** provides for the natural gas fueling off/on control function and for an optional closed loop automatic control function to optimize the amount of natural gas substitution of diesel fuel under varying modes of operation. Additionally, the **DE-3010** provides for remote data acquisition and supervisory control in a compact, low cost package dedicated to natural gas fuel substitution on industrial diesel engine applications.

Note: Engine must be equipped with an ISOCHRONOUS governor to operate properly with the GTI Bi-Fuel system.



2.0 DISPLAY MODULE

- 2.1** The Display Module serves as the user interface for the **DE-3010** system. Packaged in a 6.5" x 6.5" panel mounted enclosure, it consists of an alphanumeric 20-character x 4-line backlit LCD display, a 16-key front-mounted keypad, **DB-25 D-SUB** and **DB-9 D-SUB** connectors and three pairs of serial port indicators.
- 2.2** The keypad is a sealed membrane unit containing the **STOP** and **RE-SET** keys and other keys used to navigate through channel status, description, view screens, and to edit the setpoints.

NOTE: *If possible, keep the original shipping container. If future transportation or storage of the controller is necessary, this container will provide the optimum protection.*



WARNING:

THE CONTROLLER SYSTEM MUST BE CONFIGURED PRIOR TO USE. REFERENCE SECTION 12.0 PROGRAMMING INSTRUCTIONS, FOR INSTRUCTIONS DESCRIBING HOW TO CONFIGURE THE CONTROLLER FOR THE SPECIFIC APPLICATION. VERIFY THE PROGRAM IN NONVOLATILE MEMORY (THE EEPROM) PRIOR TO STARTING THE SYSTEM.

- 2.3** The LCD has a “home screen” that displays a status line, **BI-FUEL OFF** or **ON**, gas supply pressure (**GSP1**), manifold air pressure (**MAP1**) and engine manifold temperature (**MAT1**). Pressing the **VIEW CHANNEL** key displays the channel number, its timer status, analog value (if applicable) and the user label.
- 2.4** The keypad, along with the LCD display, are used to navigate through channel status and descriptions, view screens, and to view or edit the system’s configuration. The **↑UNITS** or **↓UNITS** or the **→TENS** or **←TENS** keys are used to access channels by increasing or decreasing the channel numbers by one or by ten with each key press. Pressing the **NEXT** key advances the display to the next screen or item. All menu adjustments are saved in nonvolatile EEPROM memory by pressing the **ENTER** key. The EEPROM memory retains the current configuration during normal operation, after engine shutdown and a system powerdown.
- 2.5** Three pairs of LED’s are provided on the back of the Display Module for troubleshooting purposes, one Receive (**RX**) and one Transmit (**TX**) LED for each port. The **TX** LED will flash when the Display Module is transmitting serial communications on the labeled port. The **RX** LED will flash when the Display Module is receiving serial communications on the labeled port.

3.0 TERMINAL MODULE

- 3.1** The 24 Vdc power for the **DE-3010** system is applied to the Terminal Board **691172-1**. A 6.3 amp replaceable slow-blow fuse protects the system from over currents, and a power LED lights when power is applied to the system.
- 3.2** The Terminal Module is rail-mounted and is the point of interface between the field sensor wiring terminal strip and the **DE-3010** control system. A removable dual terminal strip is used for the connection of the system.

NOTE: Avoid mounting the panel with the LCD display facing direct sunlight. The display operating temperature range is 31°F to +176°F (35°C to +80°C). The panel(s) should be mounted within 30 feet of the engine, the fuel solenoid valve and fuel pressure regulator.

4.0 MOUNTING THE PANEL (FIG. 4, FIG. 5)

- 4.1** Mount the control panel(s) to a post or to a suitable flat surface so that the display is at a convenient viewing height.

5.0 WIRING

5.1 SYSTEM COMPONENT WIRING (FIG. 10)

Up to four individual wiring harnesses are provided in the system kits. Each wiring harness or “bundle” is made up of functionally grouped connections to sensors or actuators which would normally be located in the same general area. Each bundle is marked as **Left Bank Harness**, **Right Bank Harness**, **Fuel Harness**, or **Power Harness**. The wiring is protected by a flexible plastic tubing and is approximately 30 feet long. Each wiring bundle is provided with a bulkhead fitting installed. Mount the bulkhead fittings into the holes provided in the bottom of the panel. When routing the wiring, it is essential that the following practices be adhered to:

- NEVER RUN SENSOR WIRES IN THE SAME CONDUIT WITH HIGH ENERGY WIRING SUCH AS THE AC LINE POWER.
- KEEP HIGH VOLTAGE WIRING AT LEAST EIGHT INCHES (200MM) AWAY FROM SENSOR AND SENSOR WIRING.
- IF IT BECOMES NECESSARY TO CHECK SENSOR TO PANEL WIRING WITH AN OHMMETER OR OTHER CHECKER, FIRST DISCONNECT THE PLUG-IN TERMINAL STRIPS FROM THE TERMINAL MODULE. APPLYING VOLTAGE TO THE DE-3010 SYSTEM THROUGH THE SENSOR LEADS MAY DAMAGE THE DEVICE.

5.2 LEFT BANK (ORANGE) HARNESS WIRING (FIG. 10)

- A. Mount the pressure sensors provided in the accessory kit to the engine in a manifold or tube from the engine. Mount these on the left bank of a V-type engine. Depending upon the specific application there may be unused wires in the bundle. Plug in the mating connectors, **VAC1** is the air cleaner vacuum and **MAPX** is the appropriate **MANIFOLD AIR PRESSURE**.
- B. Mount the thermocouples to the engine routing the thermocouple wires as required. To accommodate the differences in location of the sensors, remove the individual wires from the plastic tubing as required and tape the tubing closed after proper length to reach the sensor location is known. **MAT1** is the **MANIFOLD AIR TEMPERATURE** and **EGT1** is the **EXHAUST GAS TEMPERATURE**.
- C. If the optional vibration sensor is used, mount as indicated and connect to the wires marked **VIB+** (+24vdc) and **VIB1L** (signal to panel). **VIB2L** is used for the second transmitter on the same bank.
- D. At the panel end adjust the length of the bundle if required and mount the bulkhead fitting thru the far left hole viewing the panel from the front. Terminate the wires to the customer connection terminal strip. Each wire is marked with the same identifier as the terminal strip; connect these to match.

NOTE: Do not expose the pressure transducer to temperatures above 221°F. (105°C).

NOTE: Wires from the **LEFT BANK** harness connect to **ORANGE** terminals, wires from the **FUEL** harness connect to **BLUE** terminals, and wires from the **POWER** harness connect to **RED** terminals.

NOTE: Wires from the **RIGHT BANK harness** connect to **GREEN** terminals, wires from the **FUEL harness** connect to **BLUE** terminals, and wires from the **POWER harness** connect to **RED** terminals.

5.3 RIGHT BANK (GREEN) HARNESS WIRING (FIG. 10)

- A. Mount the pressure sensors provided in the accessory kit to the engine in a manifold or tube from the engine. Mount these on the right bank of a V-type engine. Depending upon the specific application there may be unused wires in the bundle. Plug in the mating connectors, **VAC2** is the air cleaner vacuum and **MAPX** is the appropriate **MANIFOLD AIR PRESSURE**.
- B. Mount the thermocouples to the engine routing the thermocouple wires as required. To accommodate the differences in location of the sensors remove the individual wires from the plastic tubing as required and tape the tubing closed to hold wires after proper length to reach the sensor location is known. **MAT2** is the **MANIFOLD AIR TEMPERATURE** and **EGT2** is the **EXHAUST GAS TEMPERATURE**.
- C. If the optional vibration sensor is used, mount as indicated and connect to the wires marked **VIB+** (+24vdc) and **VIB1R** (signal to panel). **VIB2R** is used for the second transmitter on the same bank.
- D. At the panel end adjust the length of the bundle if required and mount the bulkhead fitting through the second from the left hole, viewing the panel from the front. Terminate the wires to the customer connection terminal strip. Each wire is marked with the same identifier as the terminal strip; connect these to match.

5.4 FUEL (BLUE) HARNESS WIRING (FIG. 10)

The **FUEL HARNESS** contains the wiring to the fuel supply and pressure regulator and is not to be routed to the engine.

- A. After mounting the **FUEL GAS SOLENOID VALVE**, connect the **SOL+** and **SOL-** wires to the solenoid coil.
- B. Connect the **ROP** wires to the **REGULATOR OUTPUT PRESSURE** switch terminals. Do not connect the shield wire, it is terminated at the panel end only.
- C. Mount the **GAS SUPPLY** pressure transducer **GSP** and plug in the connector.
- D. At the panel end adjust the length of the bundle if required and mount the bulkhead fitting through the third from the left hole viewing the panel from the front. Terminate the wires to the customer connection terminal strip. Each wire is marked with the same identifier as the terminal strip; connect these to match.

5.5 POWER (RED) HARNESS WIRING (FIG. 10)

The **POWER HARNESS** contains the power wiring for the panel.

- A. Connect the supply power wires to the 24 Vdc input power terminals on the power supply, plus to terminal (+) and minus to terminal (-); power requirement is 24 Vdc, 10 watts max. The DC terminal will be connected to the panel ground which must be the same as engine chassis ground.
- B. At the panel end adjust the length of the bundle if required and mount the bulkhead fitting through the far right hole viewing the panel from the front. Terminate the wires to the customer connection terminal strip. Each wire is marked with the same identifier as the terminal strip; connect these to match.

NOTE: This is the return path for normally open sensors and must be connected to the engine block or chassis ground for proper operation.

5.6 DGCS PANEL WIRING (FIG. 10)

- A. Mount the diesel fuel flow meter display into the front of the **GPN0900** enclosure using the mounting hardware provided with the flow meter.
- B. Plug the pre-wired harness for the flow meter into the back of the flow meter display.
- C. Connect the flow meter sensors to the terminals.
- D. Connect the gas valve harness **693013-1** to the output terminal strip **TS-2** of the Stepper Motor Controller **691156-1** as shown on **FIG. 11**.
- E. Connect the 4-20 ma. input on **TS-1** of the Stepper Motor Controller inside the **GPN0900** enclosure, to the **ANALOG OUTPUT #1** (terminals **90+** and **90-**) of the **DE-3010** Terminal Board inside the panel.
- F. Connect the 24 volt power to the terminals provided on **TS-3** inside the **GPN0900**. The **DGCS** system should now be completely wired. Refer to **SECTION 14.0** for programming the **DGCS** function.

6.0 KEYPAD DESCRIPTION

6.1 The **DE-3010** controller Display Module contains a 16-key sealed membrane keypad which is used to adjust, stop and reset the system.

6.2 STOP

The **STOP** key is used for a manual stop condition. By pressing the **STOP** key, the controller activates the configured digital outputs in the terminal board.

6.3 RESET

The **RESET** key clears all past faulted points and resets all input and output timers to their preset values. This can also be accomplished remotely by interrupting the DC power to the panel for 5 seconds.

6.4 CANCEL TIMERS

The **CANCEL TIMERS** key cancels all timers.

6.5 VIEW CHAN

The **VIEW CHANNELS** key allows the user to view the status of any input channel and its user defined label.

6.6 NEXT

The **NEXT** key allows the user to view the **DYNAMIC FLOW CONTROL** screen from the home screen. From the **MENU** screens, the next value to be edited will appear.

6.7 ENTER

The **ENTER** key is used to accept a selection and to save a new value in memory.

6.8 ESC

The **ESCAPE** key enables the user to exit any view channels, information or menu screens at any time and return to the previous screen without changing programmed values.

6.9 MENU

The menu key allows the user to enter the edit menu. Control set-points may be viewed and adjusted using the **MENU** key.

6.10 UNITS/TENS

↑**UNITS**/↓**UNITS** keys increase or decrease values by one. The →**TENS**/←**TENS** keys increase or decrease values by ten. These keys are used to increase or decrease channel numbers, timers and to move the pointer in the menu screen.

6.11 F1

Function key **F1** displays the hourmeter. From control screen, it switches between auto and manual modes.

6.12 F2

Function key **F2** displays the time and date of the first fault.

GTI V-ENGINE CONTROL SYSTEM

7.0 UNDERSTANDING THE HOME SCREENS

7.1 The “home screens” are described as a series of screens used to display several of the most critical operating parameters on one screen. All of the home screens provide a status word on the upper line.

The status line will read one of the following: **BI-FUEL ON**, **BI-FUEL OFF**, **BI-FUEL INHIB**, **TIMERS ACTIVE**, **CHECKING INPUTS**, **FAULT AL1**, **MANUAL STOP**.

The LCD display always reverts to one of the home screens after a keypad operation is completed or the operation times out.

7.2 To activate the Bi-Fuel system, turn on the power; the unit automatically resets. If no system faults are detected during the **CHECKING INPUTS** scan, the home screen will display the **TIMERS ACTIVE** message until the programmed fuel delay timer expires. After the time delay is completed, the home screen will display either the **BI-FUEL ON** or **BI-FUEL OFF** status according to the current conditions and the programmed control values. The **RESETTING** message will be displayed momentarily followed by **TIMERS ACTIVE**, and the home screen will then re-appear.

RESETTING

APPEARS IMMEDIATELY AFTER POWER-UP OR A USER **RESET** COMMAND FOR ABOUT 1 SECOND

CHECKING INPUTS
GSP1 9.0 PSIG
MAP1 12.0 PSIG
MAT1 66 °F

APPEARS AFTER **RESET** AS UNIT SCANS INPUTS FOR PRE-EXISTING FAULT CONDITIONS

STATUS TIMERS ACTIVE
GSP1 9.0 PSIG
MAP1 12.0 PSIG
MAT1 66 °F

APPEARS AFTER **RESET** WHEN NO FAULTS ARE DETECTED AND THE PROGRAMMED **BI-FUEL** DELAY TIMER IS ACTIVE

STATUS BI-FUEL ON
GSP1 9.0 PSIG
MAP1 12.0 PSIG
MAT1 66 °F

APPEARS WHEN ALL TIMERS ARE EXPIRED, ALL FAULTS ARE CLEAR AND ALL CONTROL SETTINGS ARE PERMITTING THE **BI-FUEL** GAS VALVE TO BE **ON**

7.3 From the home screen, the optional **DYNAMIC GAS CONTROL SYSTEM (DGCS)** home screen is accessed by pressing the **NEXT** key once. The **DYNAMIC GAS CONTROL SYSTEM** which can be activated when programming the unit, adds the ability to change the amount of natural gas substitution on the basis of the generator load in order to optimize the diesel fuel usage reduction. Standard Bi-Fuel control typically regulates gas flow in a constant manner via the gas mixing valve on the basis of air flow into the engine. The **DGCS** adds the ability to independently adjust the flow of natural gas to achieve a target diesel fuel flow percent (**DFUEL**) on the basis of the generator power output. The generator KW sensor is used as an indicator of engine load. In order to control the Bi-Fuel substitution rate in a closed loop manner, a fuel pressure modulation valve is added between the fuel pressure regulator and the mixer. The percentage that this valve is **OPEN** is controlled by the **DE-3010** output. This home screen will display the current controller mode **AUTO** or **MANUAL** and status of the controller function including hold position, increase gas and decrease gas. Additionally, Bi-Fuel inhibit conditions caused by secondary control inputs overriding the primary controller output are also displayed.

NOTE: This screen will not appear on systems without the optional DGCS enabled.

```
GAS VALVE: AUTO
HOLD POSITION    95%
DFUEL 45.2% SP 45.2%
KW 88.5%
```

PRESS
TO
VIEW

NEXT

To disable the optional automatic control and force the controller output to a particular value press the **F1** key. The display will indicate that the unit is in **MANUAL** and the current value of the output. Use the **UNITS** arrow keys to change the value.

```
GAS VALVE: MANUAL
HOLD POSITION    95%
ACT 48.0% SP   45.2%
KW 88.5%
```

PRESS TO
CHANGE
MODE

PRESS TO
CHANGE
VALUE

NEXT

↑
UNITS

GTI V-ENGINE CONTROL SYSTEM

- 7.4** The **DE-3010** controller continuously monitors the system for two different levels of setpoints. The first group are called control setpoints and when violated cause the Bi-Fuel function to be temporarily suspended (engine reverts to 100% diesel operation) until conditions change. The violation of these setpoints may occur readily in normal operation of the engine and the system does not require any **USER** intervention to begin re-supplying natural gas when these clear.

```
STATUS  BI-FUEL OFF
GSP1    9.0 PSIG
MAP1    12.0 PSIG
MAT1    66 °F
```

APPEARS WHEN ALL TIMERS ARE EXPIRED, ALL FAULTS ARE CLEAR AND ONE OR MORE CONTROL SETTINGS ARE KEEPING THE **BI-FUEL** GAS VALVE IN THE **OFF** POSITION UNTIL CONDITIONS CHANGE

```
STATUS BI-FUEL INHIB
GSP1    9.0 PSIG
MAP1    12.0 PSIG
MAT1    66 °F
```

APPEARS WHEN CHANNEL 13 HAS BEEN ACTUATED

A temporary Bi-Fuel Inhibit can be implemented when desired, by grounding input 13. This input prevents output #4 from turning on, which prevents Bi-Fuel operation. Bi-Fuel operation may begin after input 13 is no longer actuated.

- 7.5** The second level of monitored setpoints are the safety shutdowns. When any of these setpoints are violated even momentarily, the Bi-Fuel will stop supplying natural gas (engine reverts to 100% diesel operation) and will **NOT** begin re-supplying gas, until a **USER** initiated **RESET** is received. When one of the safety shutdown setpoints has been violated, the gas solenoid valve is closed, and the **FAULT** message for the first faulted channel will appear on the display and will remain until it is acknowledged by a **RESET**. The number 1, after **AL** (alarm), shows the output switch that is faulted. If all of the faulted sensors have been cleared and the **RESET** key is pressed, the class B and output timers will reset and the display will repeat the sequence of **SECTION 7.2**.

```
STATUS  FAULT AL1
1ST FAULT
CHAN 12a
ROP1 REG. OUT. PRESS
```

RETURNS
TO HOME
SCREEN

ESC

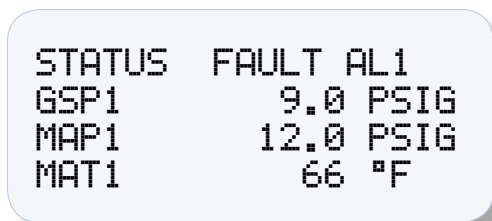

PRESS TO RETURN TO 1ST FAULT SCREEN

TO CLEAR FAULTS, RESET TIMERS & OUTPUTS

VIEW CHAN **RESET**

When a fault occurs on an analog channel, a **HIGH** or **LOW** indication will additionally be displayed as to whether the point faulted on a high or low setpoint.

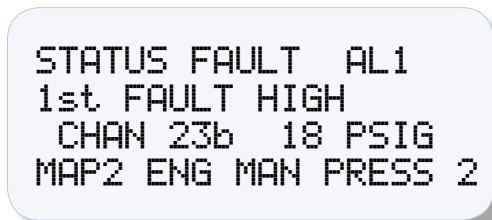

A HIGH SETPOINT FAULTED ON AN ANALOG INPUT. THE CURRENT ANALOG VALUE AND **HIGH** ARE DISPLAYED

The **DE-3010** controller system “stamps” the time and date occurrence of the first fault. To view the time and date of the first fault, press the **F2** key after a fault occurs but before reset is initiated. The time and date of the first fault will be displayed. If no key is pressed for 10 seconds, the display will revert to the first fault screen.

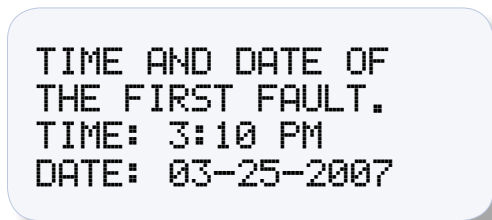

VIEW TIME & DATE OF FIRST FAULT

F2

7.6 The **MANUAL STOP** message will supersede all of the above home screens if the **STOP** key is pressed. The fuel solenoid valve will close and remain closed until **RESET**.

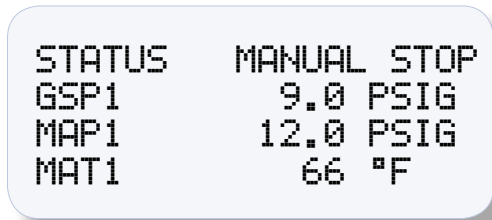

PRESS TO STOP

STOP

8.0 VIEW CHANNEL STATUS SCREENS

8.1 Use the **VIEW CHAN** key to enter the view channels screens. Once in the **VIEW CHAN** mode, the user can view any channel's details. Upon pressing the **VIEW CHANNEL** key, channel 13 will be shown. The **UNITS** and **TENS** keys allow the user to quickly navigate through the controller channels. Use the **↑UNITS** or **↓UNITS** keys to increase or decrease the viewed channel by one. Use the **→TENS** or **←TENS** keys to increase or decrease the viewed channel by ten. To exit the **VIEW CHAN** mode, press the **ESC** key.

9.0 VIEWING OR EDITING THE SETPOINT VALUES USING THE MENU MODE

9.1 The menu screens can be accessed from any home screen by pressing the **MENU** key. The menu screens allow the user to view or edit values, and the time and date. The controller must be initially configured using the terminal program running on a PC connected to the RS-232 port on the back of the controller. Reference the programming instructions **SECTION 14.0** for details on how to configure the controller system for a specific application. The menu screens are intended to view or edit the already programmed values in the field. Changes made in the menu are stored in permanent memory and remain fixed until changed again.

9.2 To view the controller configuration, from the home screen press the **MENU** key. To edit the controller configuration, the controller system requires a password key sequence.

The password procedure is: Press the **MENU** key. Then press the **F2** key followed by the **F1** key. Upon pressing this sequence, changes can be made to the configuration.

9.3 The menu screens have two levels. The first level lists the headings of the items to be viewed or edited. Upon selecting one of the headings, the second level is displayed. Press the **MENU** key to enter the first level of the menu screens. The arrow points to the first selection to be viewed or edited. Three keys can be used to navigate the first level of menu selections: **NEXT** or **↑UNITS** or **↓UNITS** keys. The **NEXT** key will move the arrow down one selection. The **↑UNITS** or **↓UNITS** keys will move the selector arrow up or down one selection. Once the arrow is pointing to the selection group to be edited, press the **ENTER** key. The display will advance to the second level to view or allow changes to the values.

NOTE: TO EDIT ANY VALUE, THE PASSWORD COMBINATION MUST BE ENTERED FROM FIRST LEVEL MENU. PRESS THE F2 KEY FOLLOWED BY THE F1 KEY. UPON PRESSING THIS SEQUENCE, CHANGES CAN BE MADE TO THE CONFIGURATION.

9.4 To edit the setpoint values, point to **EDIT CONTROL VALUES** and press the **ENTER** key. The edit control values menu is shown. The arrow points to the **EDIT SETPOINTS**. The example shows how to change the **LO** setpoint of **CHAN 23a**. Use arrow keys as shown to select desired channels. Use **ENTER** key as shown to select **LO** or **HI** setpoint.

```

→EDIT CONTROL VALUES
EDIT SAFETY SHUTDOWN
CALIBRATION
MORE MENUS
    
```

FIRST GROUP OF MENU SCREENS

```

→EDIT SETPOINTS
EDIT DYNAMIC VALUES
    
```

PRESS TO EDIT SETPOINTS

ENTER

```

→CHAN 20 (CONTROLS)
LO SP      0.0%
HI SP      0.0%
DIESEL FUEL PERCENT
    
```

TO SELECT CHAN 23a PRESS 4 TIMES

↑ UNITS

```

→CHAN 23a (CONTROLS)
LO SP      2.0 PSIG
HI SP      15.0 PSIG
MAP1 ENG MAN PRESS 1
    
```

PRESS TO EDIT LO SETPOINT

ENTER

```

CHAN 23a (CONTROLS)
LO SP      → 2.0 PSIG
HI SP      15.0 PSIG
MAP1 ENG MAN PRESS 1
    
```

PRESS TO CHANGE LO VALUE

ACCEPT AND GO TO HI VALUE

↑ UNITS **ENTER**

GTI V-ENGINE CONTROL SYSTEM

- 9.5** To edit the **DGCS** dynamic control values, select **EDIT CONTROL VALUES** from main menu and press the **ENTER** key. The edit control values menu is shown. The arrow points to the **EDIT DYNAMIC VALUES**.



EDIT SETPOINTS →EDIT DYNAMIC VALUES	PRES TO EDIT PRIM. CONTROLS	ENTER
DYNAMIC VALUES CYCLE TIME → 2 s PROP. BAND 40 % DEAD BAND 0.5 %	PRES TO CHANGE VALUE	↑ UNITS
	PRES TO ACCEPT OR GO TO NEXT VALUE	ENTER



- 9.6** To view or edit safety shutdown values, choose **EDIT SAFETY SHUTDWN** from the main menu. To edit or view setpoints, choose **EDIT SETPOINTS**.

EDIT CONTROL VALUES →EDIT SAFETY SHUTDWN CALIBRATION MORE MENUS	FIRST GROUP OF MENU SCREENS	PRES TO GO TO NEXT MENU	ENTER
→EDIT SETPOINTS VIEW INPUT CLASS	SECOND GROUP OF MENU SCREENS	PRES TO GO TO NEXT SCREEN	ENTER
CHAN →20 (SAFETY) LO SP 0.0% HI SP 0.0% DIESEL FUEL PERCENT	PRES TO GO TO LO SETPOINT		ENTER

9.7 To view or edit the sensor calibration, select **CALIBRATION** from the main menu. Use the arrow keys to select the desired channel for calibration. Use the **ENTER** key to select either zero or span calibration for the selected channel. Watching the bottom line of the display use the arrow keys to display the desired value. For example, in order to calibrate the zero value of the transducer, apply the zero value to the input and follow the steps below. If the full scale value also requires calibration, apply the full scale input to the channel and adjust the span to obtain the desired reading on the bottom line of the display as shown.

<pre> EDIT CONTROL VALUES EDIT SAFETY SHUTDWN →CALIBRATION MORE MENUS </pre>	<p>FIRST GROUP OF MENU SCREENS</p>	<p>PRESS TO GO TO NEXT MENU</p>
		

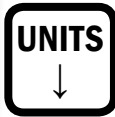
<pre> CHAN →20 ZERO CALIBRATION SPAN CALIBRATION 30.3 % </pre>	<p>ARROW KEYS TO CHANGE CHANNEL</p>	<p>PRESS TO SELECT ZERO CAL.</p>
		

<pre> CHAN 20 →ZERO CALIBRATION SPAN CALIBRATION 30.3 % </pre>	<p>ARROW KEYS TO CHANGE</p>	<p>PRESS TO SELECT SPAN CAL.</p>
		

9.8 Select **MORE MENUS** from menu.

<pre> EDIT CONTROL VALUES EDIT SAFETY SHUTDWN CALIBRATION →MORE MENUS </pre>	<p>FIRST GROUP OF MENU SCREENS</p>	<p>PRESS TO GO TO NEXT MENU</p>
		

GTI V-ENGINE CONTROL SYSTEM

- 9.9** The display shows the current Engineering units selection English or Metric, use the **UP** arrow key to change and then press **ENTER** to accept the new selection and move to Edit Time and Date.

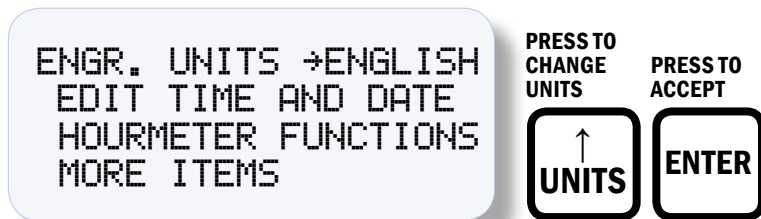

Selection arrow now points to time and date.

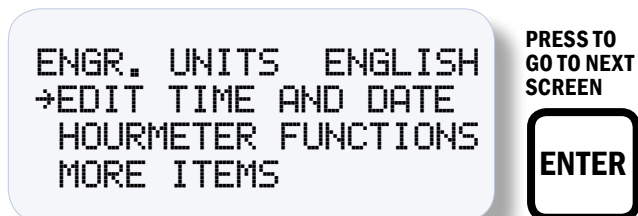

The time and date will be displayed with the selection arrow pointing to the time. The hours and minutes can be edited separately, AM and PM follow the hours. With the selection arrow pointing to the hours, use the ↑UNITS or ↓UNITS keys to increase or decrease the hours. Press **ENTER** to save the new hour setting; the selection arrow will point to the minutes. Use the same procedure to edit the minutes. Use the **NEXT** key to move through the time and date screen without making a permanent change in memory.

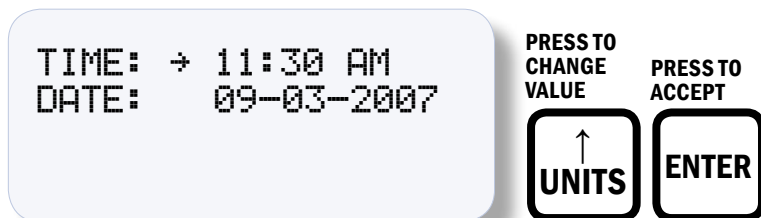

The date is shown as month-day-year. The month, day and year can be edited separately. With the selection arrow pointing to the month, use the ↑UNITS or ↓UNITS keys to increase or decrease the month. Press **ENTER** to save the new month setting; the selection arrow will point to the day. Use the same procedure to edit the day and the year.

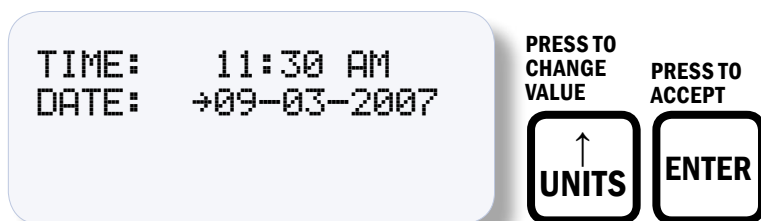

Now the time and date will be displayed with the selection arrow pointing to the time. The hours and minutes can be edited separately; AM and PM follow the hours. With the selection arrow pointing to the hours, use the **↑UNITS** or **↓UNITS** keys to increase or decrease the hours. Press **ENTER** to save the new hour setting; the selection arrow will point to the minutes. Use the same procedure to edit the minutes. Use the **NEXT** key to move through the time and date screen without making a permanent change in memory.

9.10 To view the Hourmeter message, select **HOURMETER FUNCTIONS** from the main menu and press **ENTER**.

ENGR. UNITS ENGLISH
 EDIT TIME AND DATE
 →HOURMETER FUNCTIONS
 MORE ITEMS

PRESS TO
GO TO SET
HOURMETER

ENTER

HOURMETER / SERVICE
 MESSAGE NUMBER: 00
 TOTAL HOURS: → 1500
 RUN TIME HOURS

PRESS TO
CHANGE
VALUE

↑
UNITS

PRESS TO
ACCEPT

ENTER

9.11 To view or edit the values for **VIBRATION TIMER**, **BI-FUEL DELAY TIMER**, **COMMUNICATION SETTINGS** and to view the **FIRMWARE REVISION** level, select **MORE ITEMS**. The **VIBRATION TIMER** is the length of time in seconds that a vibration level must be detected for to cause a fault. The **BI-FUEL DELAYTIMER** is the amount of time in seconds before Bi-fuel will be allowed to turn on after a power loss or reset, if no faults exist.

ENGR. UNITS ENGLISH
 EDIT TIME AND DATE
 HOURMETER FUNCTIONS
 →MORE ITEMS

PRESS TO
GO TO MORE
ITEMS

ENTER

VIBRATION TIMER →0s
 BI-FUEL DELAY 100s
 COMMUNICATIONS
 VIEW FIRMWARE REV.

PRESS TO
CHANGE
VALUE

↑
UNITS

PRESS TO
GO TO BI-
FUEL DELAY

ENTER

GTI V-ENGINE CONTROL SYSTEM

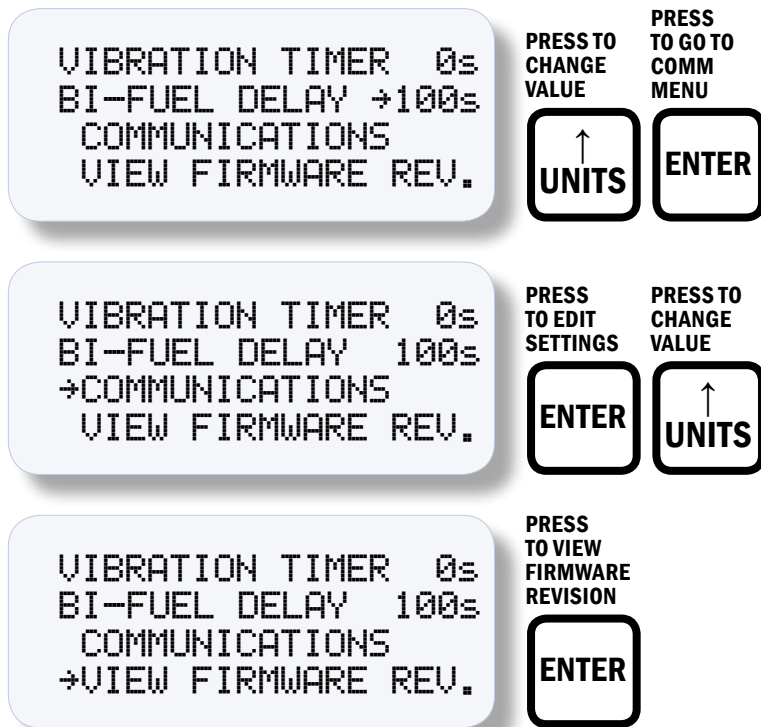

10.0 CONTRAST RATIO ADJUSTMENT

10.1 The LCD contrast ratio is adjusted for optimum contrast over a large temperature range at the factory. It may be necessary however to make slight adjustments to the LCD contrast ratio because of aging and or extreme temperature changes. The contrast ratio potentiometer (**TP1**) is located on the back of the Display Module as shown in the drawings section. Use an adjusting tool and turn the potentiometer clockwise to lighten the contrast ratio or counterclockwise to darken the contrast ratio.

To set the potentiometer back to the factory setting: with the Display Module at an ambient temperature of approximately 65°F to 77°F (18°C to 25°C), turn the potentiometer clockwise until the display contrast ratio is almost too light to read. Turn the potentiometer counterclockwise 3 to 3-1/2 turns. The display should then be at a desirable contrast ratio.

11.0 COMMUNICATION OPTIONS

11.1 The **DE-3010** controller system contains a data logging feature. Data logging collects information from the system and keeps track of, or logs, that information over a period of time. That data is then available through a PC or PLC at port 1, the **RS-232** port or port 3, the **RS-485** port.

11.2 NODE NUMBER

The node number is the address of the controller being contacted. This number is programmed by the terminal program and can be viewed or edited in the menu screen. A two digit number from 01 to 99 can be used.

11.3 COMMUNICATIONS PARAMETERS

The following must be set in the PC or PLC to communicate with the controller system:

Baud Rate: 9600
Data Bits: 8
Stop Bits: 1
Parity: None

11.4 The data logging memory can retain a total of 100 records before writing over the oldest information. The most current data is always record number one; the next most current is number two, etc. The oldest information, record 100, is lost when a new record is written. The logging period is the time between data logs and is set for 5 minutes.

A new record is also written when a first fault occurs. If the first fault occurs between the logging period, the first fault record will be record number one and the next scheduled record will be number two.

12.0 DATA LOGGING

12.1 The following describes the spacing for the fields of the **DE-3010** data logging command.

This command is functional from the **RS-232** and the **RS-485** data logging port. The communications settings are **9600, 8, N** and **1**. The node number must be correct for the **DE-3010** to respond on the **RS-485** port. The node number field is ignored on the **RS-232** port and responds accordingly.

12.2 The command to access a particular record is as follows:

>(XXDLYYY)

COMMAND HEADER ">" (0) – ASCII VALUE 3EH

BEGIN TEXT "(" (1) – ASCII VALUE 28H

DE-3010 NODE NUMBER (2-3)

This field consists of the node number associated with the particular **DE-3010**. The range is from 01 to 99

SPACE (4), (7) – ASCII VALUE 20H

COMMAND (5, 6)

The letters **D** and **L**, which stand for **DATA LOG**

REQUESTED RECORD NUMBER (8-10)

TABLE I:

This value will be between **001** and **100** and represents the requested record number. Record number **001** will always contain the most recent data log event. Record number **002** contains the second most recent data log event and so on. Requesting record number **999** gives a response which occurred due to a first fault condition. If there is no faults and **999** is requested, the **NO DATA AVAILABLE** message occurs. Requesting record number 000 transmits current status information.

TABLE II:

Shows the structure of data log command **998**. This is for the Hourmeter.

END TEXT ")" (11) - ASCII VALUE 29H

12.3 TABLE I

FIELD DESCRIPTION	EXAMPLES OF LOGGED DATA		AMT OF CHARACTERS	CHARACTER LOCATION
SITE LOCATION	GTI Bi-Fuel	GPN-2000V-D	30	0-29
CR, LF			2	30, 31
REC NUM/HOURS	022	12345 HRS	14	32 - 45
CR, LF			2	46, 47
TIME AND DATE	06-16-2006	12:02 PM	20	48 - 67
CR, LF			2	68, 69
STATUS DISPLAY	STATUS	BI-FUEL ON	20	70 - 89
CR, LF			2	90, 91
HOME LINE 2	ACT	57.7 %	20	92 - 111
CR, LF			2	112, 113
HOME LINE 3	GSP	12.3 PSIG	20	114 - 133
CR, LF			2	134, 135
HOME LINE 4	MAP1	12.5 PSIG	20	136 - 155
CR, LF			2	156, 157
VIEW scn #1, L1	VAC1	67.9 PSIG	20	158 - 177
CR, LF			2	178, 179
VIEW scn #1, L2	VAC1	62.1 PSIG	20	180 - 199
CR, LF			2	200, 201
VIEW scn #1, L3	MAP2	23.5 PSIG	20	202 - 221
CR, LF			2	222, 223
VIEW scn #1, L4	MAP3	18.8 PSIG	20	224 - 243
CR, LF			2	244, 245
VIEW scn #2, L1	MAP4	40.5 PSIG	20	246 - 265
CR, LF			2	266, 267
VIEW scn #2, L2	VIB1	0.20 IPS	20	268 - 287
CR, LF			2	288, 289
VIEW scn #2, L3	VIB2	0.22 IPS	20	290 - 309
CR, LF			2	310, 311
VIEW scn #2, L4	VIB3	0.21 IPS	20	312 - 331
CR, LF			2	332, 333
L12	VIB4	0.19 IPS	20	334 - 353
CR, LF			2	354, 355
L13			20	356 - 375
CR, LF			2	376, 377
L14			20	378 - 397
CR, LF			2	398, 399
L15			20	400 - 419
CR, LF			2	420, 421
POSS. 1ST FAULT	1ST FAULT		20	422 - 441

GTI V-ENGINE CONTROL SYSTEM

12.3 TABLE I (CONTINUED)

CR, LF		2	442, 443
POSS. FAULT CH	CHAN 40	20	444 - 463
CR, LF		2	464, 465
FAULT LABEL	VIB1 ENG VIBRATION 1	20	466 - 485
CR, LF		2	486, 487
1ST FAULT TIME	06-06-2006 11:07AM	20	488, 507
CR, LF		2	508, 509
CR, LF		2	510, 511
TOTAL CHARACTERS		512	

The following will be displayed when there is no information in the data log.

"NO DATA AVAILABLE

(CR, LF)

(CR, LF)"

Note that the spacing for the analog labels and values on the 20 character line is as follows:

LOCATION 1-? occupy the label associated with that channel.

(? dependant upon label name)

LOCATION 12-16 occupy the analog value. (100.4)

LOCATION 17 contains a space.

LOCATION 18-20 contain the units of measure. (PSI)

12.4 TABLE II

FIELD DESCRIPTION	EXAMPLES OF LOGGED DATA		AMT OF CHAR	CHARACTER LOCATION	HOOR LOCATION
SITE LOCATION	GTI Bi-Fuel	GPN-2000V-D	30	0-29	
CR, LF			2	30, 31	
REC NUM/HOURS	998	12345 HRS	14	32 - 45	
CR, LF			2	46, 47	
TIME AND DATE	06-16-2006	12:02 PM	20	48 - 67	
CR, LF			2	68, 69	
HOURMETER	RUN-TIME HOURS	12345	26	70 - 95	91-95
CR, LF			2	96, 97	
CR, LF			2	98, 99	
LABEL MESSAGE	SERVICE HOURS LEFT:		19	100 - 118	
CR, LF			2	119-120	
SERV. MSG. 1	NOT USED		26	121 - 146	142-146
CR, LF			2	147, 148	
SERV. MSG. 2	NOT USED		26	149-174	170-174
CR, LF			2	175, 176	
SERV. MSG. 3	NOT USED		26	177-202	198-202
CR, LF			2	203, 204	
SERV. MSG. 4	NOT USED		26	205-230	226-230
CR, LF			2	231, 232	
SERV. MSG. 5	NOT USED		26	233-258	254-258
CR, LF			2	259, 260	
SERV. MSG. 6	NOT USED		26	261-286	282-286
CR, LF			2	287, 288	
SERV. MSG. 7	NOT USED		26	289-314	310-314
CR, LF			2	315, 316	
SERV. MSG. 8	NOT USED		26	317-342	338-342
CR, LF			2	343, 344	
SERV. MSG. 9	NOT USED		26	345-370	366-370
CR, LF			2	371, 372	
SERV. MSG. 10	NOT USED		26	373-398	394-398
CR, LF			2	399, 400	
SERV. MSG. 11	NOT USED		26	401-426	422-426
CR, LF			2	427, 428	
RESERVED			26	429-454	
CR, LF			2	455, 456	
RESERVED			26	457-482	
CR, LF			2	483, 484	
RESERVED			25	485-509	
CR, LF			2	510, 511	

The **CHARACTER LOCATION** for the service messages consists of 20 characters which was previously programmed into the **DE-3010**. The **HOOR LOCATION** describes the position of the hours associated with the service message or with the hourmeter function. If a service message is **NOT USED**, then there will be **----** in the **HOOR LOCATION** field. Values less than 10000 hours are right justified with spaces in locations to the left. For example, the hour value of **12345** will be displayed as **12345** and an hour value of **477** will be shown as **477**.

GTI V-ENGINE CONTROL SYSTEM

13.0 COMMUNICATIONS PARAMETERS

All communications are at 9600 baud, 8 Data bits, No Parity, 1 Stop bits. (9600 8 N 1)

13.1 COMMUNICATIONS OVERVIEW

The DE-3010 is compliant to the Modicon Modbus RTU standard. The DE-3010 supports DE-3010 DISPLAY MODBUS COMMUNICATIONS. Register reads and data is duplicated for the 30000's & 40000's address range. Maximum number of registers that can be read at one time has been limited to 32.

13.2 MODBUS REGISTERS

ADDRESS	DESCRIPTION OF FUNCTION
40001	RPM; range from 0-9999
40002	Hourmeter; range from 0-65535
40003	Null, will always read 0
40004	Status (1-4,10-27,30-46) Bi-fuel shutdown on that channel. 50 = Bi-fuel ON. 51=Bi-fuel OFF. 60=STOP.
40005	Reserved
40006	Reserved
40007	Reserved
40008	Reserved
40009	0 = Low fault shutdown. 1 = High fault shutdown. Only applicable when fault exists.
40106	Analog Channel 20; range from -9999 to 9999
40107	
40108	Analog Channel 21a; range from -9999 to 9999
40109	Analog Channel 21b; range from -9999 to 9999
40110	Analog Channel 22a; range from -9999 to 9999
40111	Analog Channel 23a; range from -9999 to 9999
40112	Analog Channel 23c; range from -9999 to 9999
40113	Analog Channel 24a; range from -9999 to 9999
40114	Analog Channel 25a; range from -9999 to 9999
40115	Analog Channel 26a; range from -9999 to 9999
40116	Analog Channel 26c; range from -9999 to 9999
40117	Analog Channel 22b; range from -9999 to 9999
40118	Analog Channel 23b; range from -9999 to 9999
40119	Analog Channel 23d; range from -9999 to 9999
40120	Analog Channel 24b; range from -9999 to 9999
40121	Analog Channel 25b; range from -9999 to 9999
40122	Analog Channel 26b; range from -9999 to 9999
40123	Analog Channel 26d; range from -9999 to 9999
40124	Analog Channel 27; range from -9999 to 9999

13.2 MODBUS REGISTERS (CONTINUED)

40125	Analog Channel 30; range from -9999 to 9999
40130	Decimal Point Range for Channel 20
40131	Decimal Point Range for Channel 21a
40132	Decimal Point Range for Channel 21b
40133	Decimal Point Range for Channel 22a
40134	Decimal Point Range for Channel 23a
40135	Decimal Point Range for Channel 23c
40136	Decimal Point Range for Channel 24a
40137	Decimal Point Range for Channel 25a
40138	Decimal Point Range for Channel 26a
40139	Decimal Point Range for Channel 26c
40140	Decimal Point Range for Channel 22b
40141	Decimal Point Range for Channel 23b
40142	Decimal Point Range for Channel 23d
40143	Decimal Point Range for Channel 24b
40144	Decimal Point Range for Channel 25b
40145	Decimal Point Range for Channel 26b
40146	Decimal Point Range for Channel 26d
40147	Decimal Point Range for Channel 27
40148	Decimal Point Range for Channel 30

13.3 IDENTIFICATION

In addition to the above, the **DE-3010** will respond to function code **17** with an identification string as follows:

QUERY: NN 17 CRC CRC

NN = node number, **17** = ID function code, **CRC CRC** = two byte Modbus RTU CRC.

RESPONSE: NN 17 07 DE - 3010 CRC CRC

NN = node number, **17** = ID function code, **07** = number of bytes to follow, **DE-3010** (seven byte ASCII ID string), **CRC CRC** = two byte Modbus RTU CRC

13.4 STOP/RESET

Register **40999** can be written to to remotely trigger the **STOP & RESET** functions. It will only respond to a single write (function code **06**). The **STOP COMMAND** is **0xAC53**. The reset command is **0xBE41**.

13.5 REMOTE KEYPAD EMULATION

The **DE** has a feature called the **REMOTE KEYPAD EMULATION** that can be accessed through function code **20** as follows:

QUERY: NN 20 KP CRC CRC

NN = node number, **20** = KP function code, **KP** is the single byte **KEY PRESS** from the table below, **CRC CRC** = two byte Modbus RTU CRC.

KEY PRESS TABLE

00 = NONE (no keypress, returns current display)

01 = CANCEL TIMERS

02 = TEST

03 = RESET

04 = STOP

05 = VIEW

06 = NEXT

07 = UP/UNITS

08 = VIEW CHAN

09 = F1

10 = RIGHT/TENS

11 = ENTER

12 = LEFT/TENS

13 = F2

14 = MENU

15 = DOWN/UNITS

16 = ESC

RESPONSE: NN 20 88 (20 BYTES, 1ST LINE OF DISPLAY) CR LF (20 BYTES, 2ND LINE) CR LF (20 BYTES, 3RD LINE) CR LF (20 BYTES, 4TH LINE) CR LF CRC CRC

NN = node number, **20** = KP function code, **88** = number of bytes to follow, **CR** = Carriage Return, **LF** = Linefeed, 4 20-byte ASCII blocks that is the display, **CRC CRC** = two byte Modbus RTU CRC.

14.0 PROGRAMMING THE DE-3010

14.1 The **DE-3010** terminal program operates from a standard PC and permits the operator to configure the system. There is a monitor mode that the operator can use to monitor an existing installation and access system data. This data can be accessed locally or remotely via a modem.

The following user-supplied hardware is required:

- **COMPUTER: IBM-COMPATIBLE PC, WINDOWS 95/98/ME, HARD DRIVE (10 MB OF FREE DISK SPACE REQUIRED), CD-ROM DRIVE, SVGA GRAPHICS (800X600 OR GREATER PREFERRED) WITH COLOR MONITOR.**
- **SERIAL PORT - RS-232 PORT FOR PROGRAMMING.**
- **MODEM - 9600 BAUD (OR GREATER) MODEM REQUIRED FOR MONITOR FUNCTION.**

14.2 The terminal program installs from a CD-ROM drive. A minimum of 10MB of free disk space is required. Additional disk space will be required if the remote data log database function is used. The space required will be dependent on the size of the working database.

Insert the CD-ROM disk into the CD-ROM drive and run the setup.exe file. If you have the autorun selection enabled on your CD-ROM drive, the install program will run automatically. The install program will prompt you for a destination folder where the program will be installed. The default folder is **C:\PROGRAM FILES\ALTRONIC DE-3010TERMINAL PROGRAM**. After the install completes, you can run the program from the Windows Start button, Programs Menu, Altronic **DE-3010** system, and select the **DE-3010** menu selection.

14.3 Connect the computer cable from the computer to the **DB9 PORT #1** on the back of the **DE-3010** display.

14.4 CONFIGURE KEY

The **DE-3010** needs to be initially programmed using the **DE-3010 TERMINAL PROGRAM**. Select the items for download which best fit the intended application.

14.5 EDIT SETPOINTS KEY

The setpoints of the **DE-3010** may be changed from the computer by selecting this key.

14.6 MONITOR KEY

This feature allows the user to retrieve data logged messages which is typically used for PC monitoring or SCADA/PLC systems. The connections can use either a modem or connected directly into the Comm. Port. Data logs may be retrieved into a standard **EXCEL** file format.

The following keys are applicable during the monitor function:

CONNECT KEY

This feature selects how the PC is going to connect to the **DE-3010**. Select either a comm port or a telephone number for a modem.

HANGUP KEY

This disconnects the PC from the port or the modem.

DATALOGS KEY

This feature allows for retrieval of data logged messages in the PC. Data logs may be retrieved into a standard **EXCEL** file format.

AUTO START KEY

This feature allows for serial communications to **STOP** Bi-Fuel operation or **RESET** Bi-Fuel operation.

VIEW DATABASE/CHART DATABASE KEY

These powerful tools allow users to display and chart the data logged information.

14.7 CALIBRATE KEY

This allows the user to calibrate analog sensor channels. Press this button and select the channel to be calibrated. The sensor selection box will show the default values or the last values calibrated. The **CURRENT DATA** box shows the value being displayed by the **DE-3010**. On the terminals of the channel being calibrated, connect a voltmeter between the input (+ and -) to measure the output voltage of the transducer. Apply the desired minimum pressure, temperature, vibration, position or KW input to the transducer being calibrated. Now measure the voltage using the voltmeter on the terminal strip. Enter this voltage into the **LOW SENSOR VOLTAGE** box on the PC screen. Click the **ACCEPT** button to make this the new calibration value. The **CURRENT DATA** box will now read the desired minimum value. If the span is to be adjusted, increase the input to the transducer to the desired high value. Measure the voltage at the terminal strip using the voltmeter and enter the measured voltage in the **HIGH SENSOR VOLTAGE** box and hit the **ACCEPT** button. The calibration of the channel is now complete.

14.8 DGCS KEY

This key is used to program or modify the **DGCS** setpoint values. The **DGCS** control function allows for up to three straight line segments of different slopes to be selected by programming the endpoints of each segment. The break points are entered in standard Cartesian Coordinate format (X,Y) and the computer automatically interpolates the complete data set for downloading.

14.9 EXIT KEY

Exits the **DE-3010** PC Terminal program.

INDEX BY SECTION:

1.0 OVERVIEW

2.0 DISPLAY MODULE

3.0 TERMINAL MODULE

4.0 MOUNTING THE PANEL

5.0 WIRING

6.0 KEYPAD DESCRIPTION

7.0 UNDERSTANDING THE HOME SCREENS

8.0 VIEW CHANNEL STATUS SCREENS

**9.0 VIEWING OR EDITING THE SETPOINT VALUES
USING THE MENU MODE**

10.0 CONTRAST RATIO ADJUSTMENT

11.0 COMMUNICATIONS OPTIONS

12.0 DATA LOGGING

13.0 COMMUNICATIONS PARAMETERS

14.0 PROGRAMMING THE DE-3010

GTI V-ENGINE CONTROL SYSTEM

FIG. 1 – GTI CONTROL INPUT CHANNEL LISTING

FIG. 2. – PANEL APPLICATION CHART – SERIES III AND IV

FIG. 3 – PANEL ACCESSORY KIT - SERIES III AND IV

FIG. 4 – MOUNTING DIMENSIONS – GPN2000V

FIG. 5 – MOUNTING DIMENSIONS – GPN2212V

FIG. 6 – INSIDE VIEW – GPN2010V

FIG. 7 – INSIDE VIEW – GPN2212V

FIG. 8 – INSIDE VIEW – GPN2213V

FIG. 9 – INSIDE VIEW – GPN2214V

**FIG. 10 – WIRING DIAGRAM – CUSTOMER CONNECTIONS – GPN2010V, GPN2212V,
GPN2213V, GPN2214V**

FIG. 11 – WIRING DIAGRAM – STEPPER MOTOR CONTROLLER – GPN2212V, GPN2214V

FIG. 12 – WIRING DIAGRAM – TEMPERATURE MONITORING TERMINAL – P/N 691172-2

**FIG. 13 – WIRING DIAGRAM – SENSOR TERMINAL – GPN2010V, GPN2212V, GPN2213V,
GPN2214V**

FIG. 14 – LADDER LOGIC

FIG. 1 – GTI CONTROL INPUT CHANNEL LISTING

CHANNEL	DESCRIPTION	DISPLAYED UNITS (Default: English)	DISPLAYED UNITS (Metric)	DEFAULT CONTROL SETPOINTS		DEFAULT SAFETY SETPOINTS	
				LOW	HIGH	LOW	HIGH
12a	ROP SWITCH 1	–	–	–	–	–	–
12b	ROP SWITCH 2	–	–	–	–	–	–
13	BI-FUEL INHIBIT	–	–	–	–	–	–
14	GAS DETECT	–	–	–	–	–	–
15	A/F RATIO	–	–	–	–	–	–
20	DIESEL FUEL PERCENT	%	%	0	100	0	100
21a	GSP1	PSIG	Kpa	-12.5	62.5	-12.5	62.5
21b	GSP2	PSIG	Kpa	-12.5	62.5	-12.5	62.5
22a	VAC1	PSIG	Kpa	-12.5	62.5	-12.5	62.5
22b	VAC2	PSIG	Kpa	-12.5	62.5	-12.5	62.5
23a	MAP1	PSIG	Kpa	20	62.5	20	62.5
23b	MAP2	PSIG	Kpa	-12.5	62.5	-12.5	62.5
23c	MAP3	PSIG	Kpa	-12.5	62.5	-12.5	62.5
23d	MAP4	PSIG	Kpa	-12.5	62.5	-12.5	62.5
24a	MAT1	°F	°C	-76	1472	-76	1472
24b	MAT2	°F	°C	-76	1472	-76	1472
25a	EGT1	°F	°C	-76	1472	-76	1472
25b	EGT2	°F	°C	-76	1472	-76	1472
26a	VIB1 or VIB1L	IPS	MPS	0	2	0	2
26b	VIB1R	IPS	MPS	0	2	0	2
26c	VIB2L	IPS	MPS	0	2	0	2
26d	VIB2R	IPS	MPS	0	2	0	2
27	KW PERCENT	%	%	0	100	0	100
30	A/F RATIO	%	%	0	100	0	100
101–120	EXH. TEMP. (2nd Term. Brd.)	°F	°C	20	62.5	20	62.5
				0	1472	0	1472
6	No. Discrete			0	1472	0	1472
39	No. Analog			-0.5	2.50	-0.5	2.50
				-25	125	-25	125
15	Unused Discrete			–	–	–	–
	Unused Analog			–	–	–	–

DE TERMINAL PROGRAM CONFIGURATION DEFAULTS

Device/Units: GPN2010V Controller (English)

Kit: Kit D (GPA0004 Panel Accessory Kit)

No. of Vibration Sensors: 4 (2 per bank)

With Dynamic Control System: Yes

GTI V-ENGINE CONTROL SYSTEM

FIG. 2 – PANEL APPLICATION CHART – SERIES III AND IV

ENGINE TYPE	V-ENGINE COMMON MANIFOLD	V-ENGINE DUAL MANIFOLDS	V-ENGINE QUAD MANIFOLDS
Bi-Fuel Kit Series	III-B, IV-B	III-C, IV-C	III-D, IV-D
Panel Accessory Kit (see detail below)	GPA0002	GPA0003	GPA0004
Control Panel	GPN2000V	GPN2000V	GPN2000V
DGCS Panel	GPN0900	GPN0900	GPN0900

FIG. 3 – PANEL ACCESSORY KIT - SERIES III AND IV

PANEL ACCESSORY KIT:		KIT B GPA0002	KIT C GPA0003	KIT D GPA0004
Left Bank Harness	PART NO.	693118-1	693118-1	693120-1
	FUNCTIONS	MAP1 VAC1 EGT1 MAT1 VIB+, VIB1L, VIB2L KW	MAP1 VAC1 EGT1 MAT1 VIB+, VIB1L, VIB2L KW	MAP1 MAP3 VAC1 EGT1 MAT1 VIB+, VIB1L, VIB2L KW
Right Bank Harness	PART NO.	693121-1	693122-1	693123-1
	FUNCTIONS	VAC2 EGT2 VIB+, VIB1R, VIB2R	MAP2 VAC2 EGT2 MAT2 VIB+, VIB1R, VIB2R	MAP2 MAP4 VAC2 EGT2 MAT2 VIB+, VIB1R, VIB2R
Fuel Harness Assembly	PART NO.	693124-1	693124-1	693124-1
	FUNCTIONS	GSP ROP SOL+, SOL-	GSP ROP SOL+, SOL-	GSP ROP SOL+, SOL-
Power Harness Assembly	PART NO.	693125-1	693125-1	693125-1
	FUNCTIONS	+, -, GND	+, -, GND	+, -, GND
691201-15 Transducer		1 - GSP	1 - GSP	1 - GSP
691201-50 Transducer		1 - MAP1	1 - MAP1, MAP2	1 - MAP1, 2, 3, 4
691206-50 Transducer		1 - VAC1, VAC2	1 - VAC1, VAC2	1 - VAC1, VAC2

FIG. 4 – MOUNTING DIMENSIONS – GPN2010V

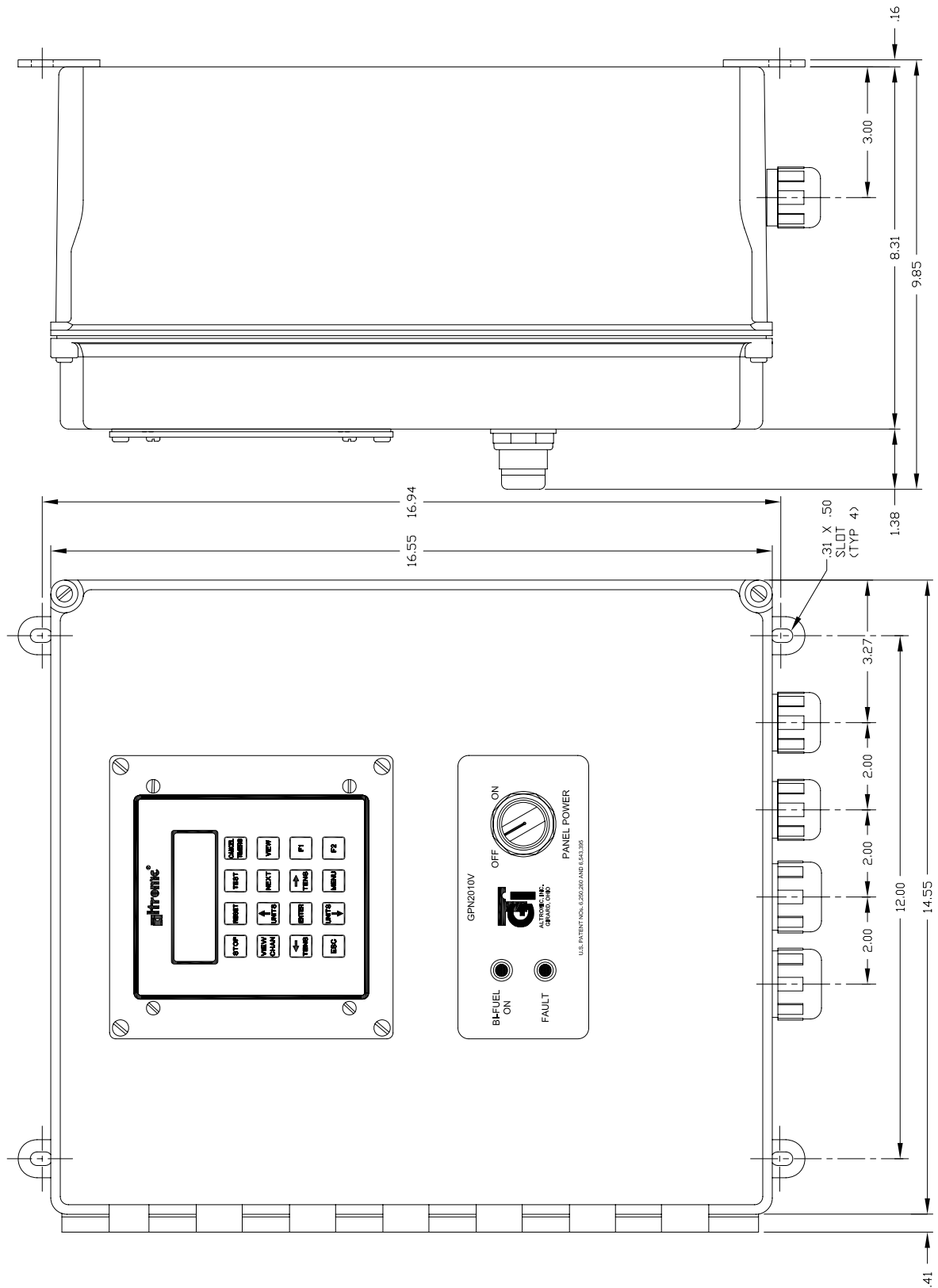

FIG. 5 – MOUNTING DIMENSIONS – GPN2212V

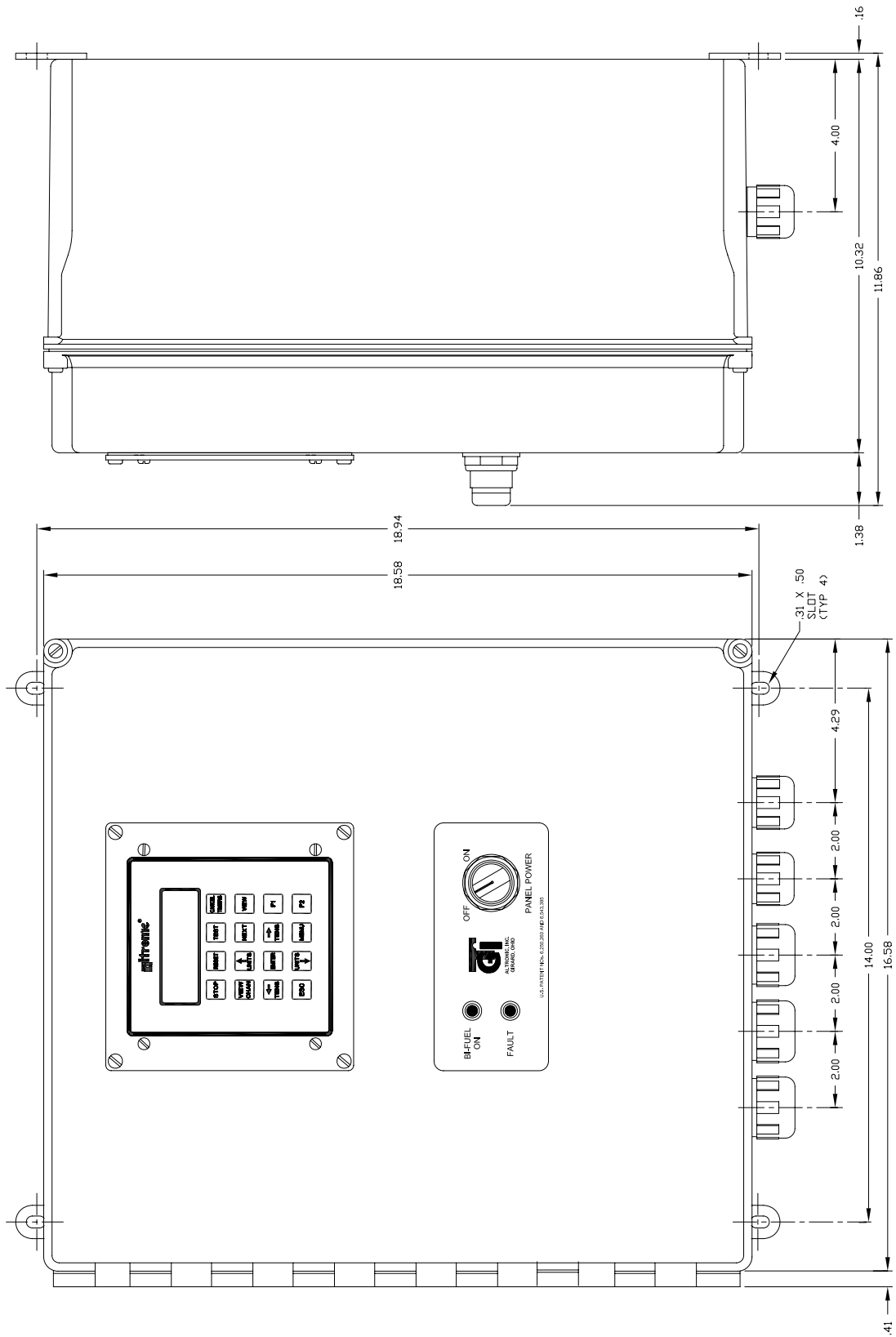
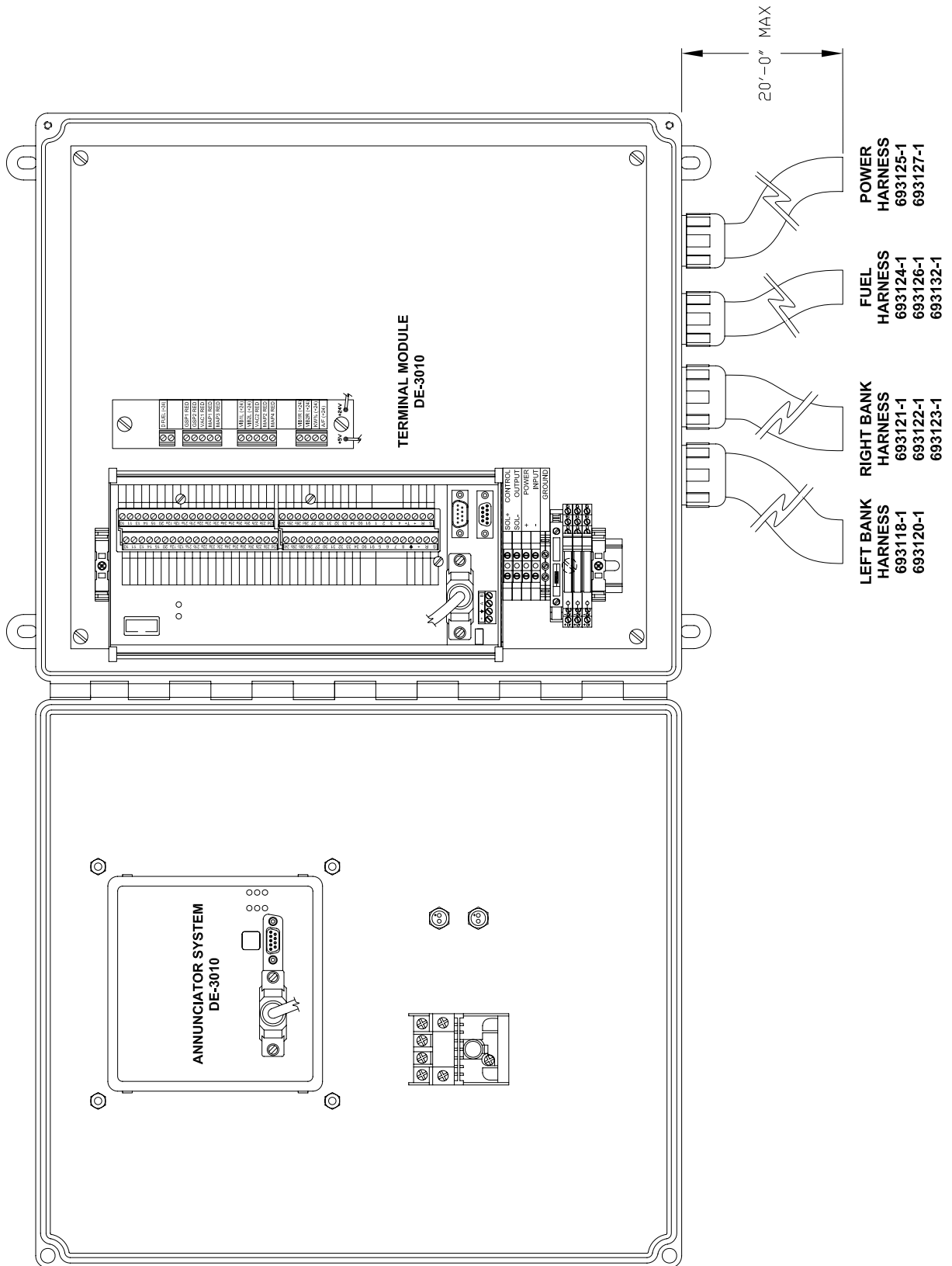

FIG. 6 – INSIDE VIEW – GPN2010V



GTI V-ENGINE CONTROL SYSTEM

FIG. 7 – INSIDE VIEW – GPN2212V

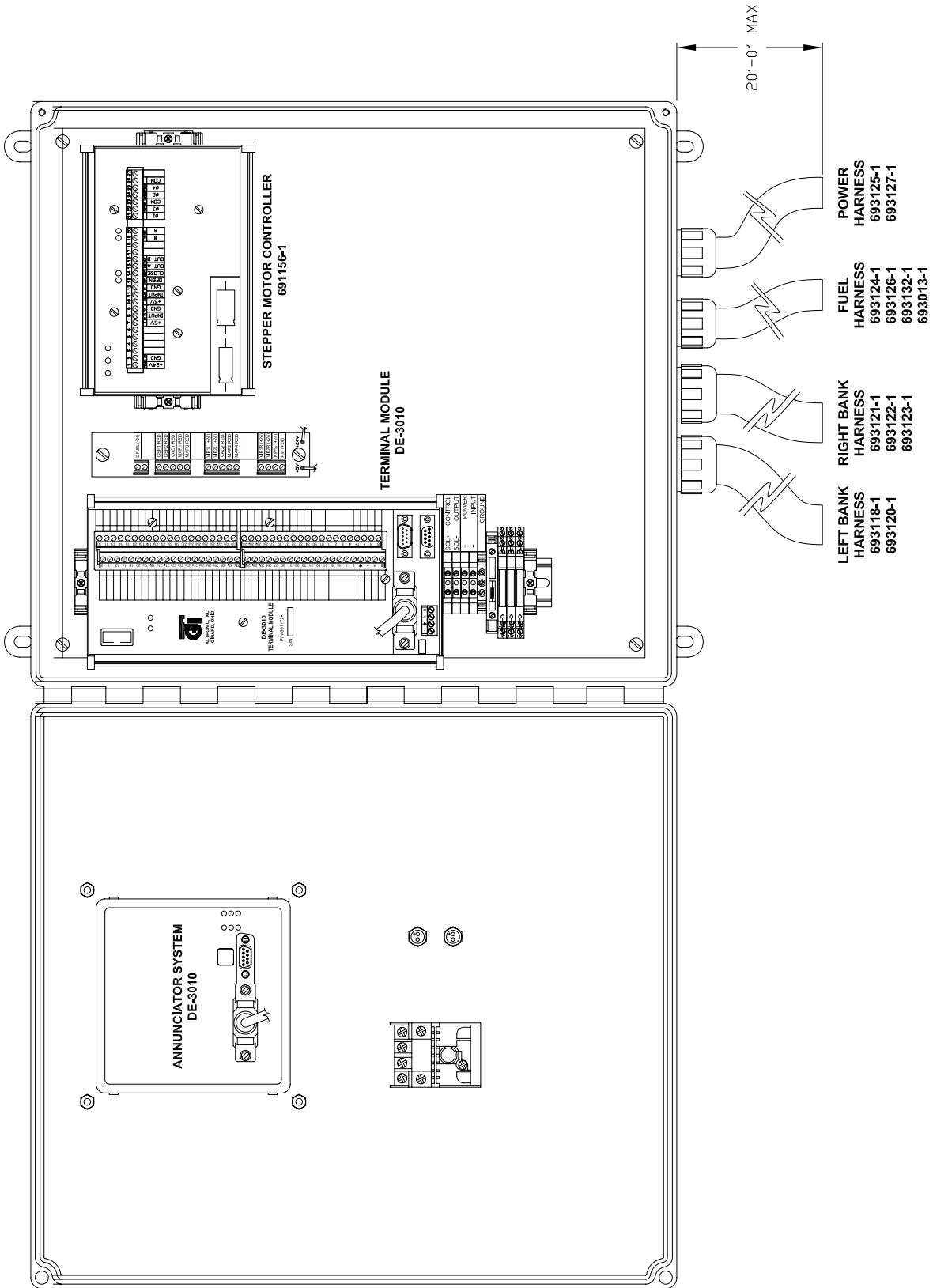
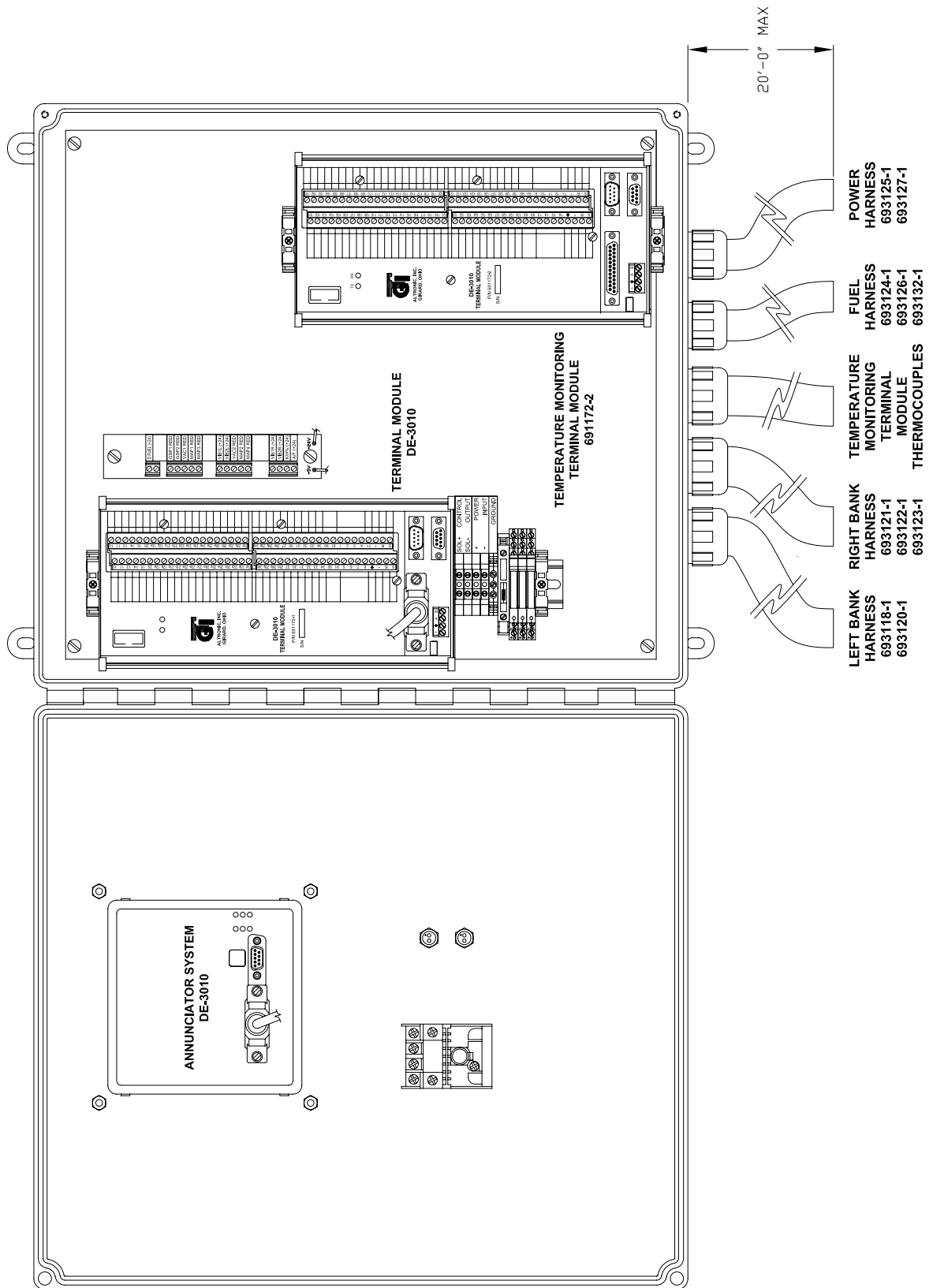

FIG. 8 – INSIDE VIEW – GPN2213V



GTI V-ENGINE CONTROL SYSTEM

FIG. 9 – INSIDE VIEW – GPN2214V

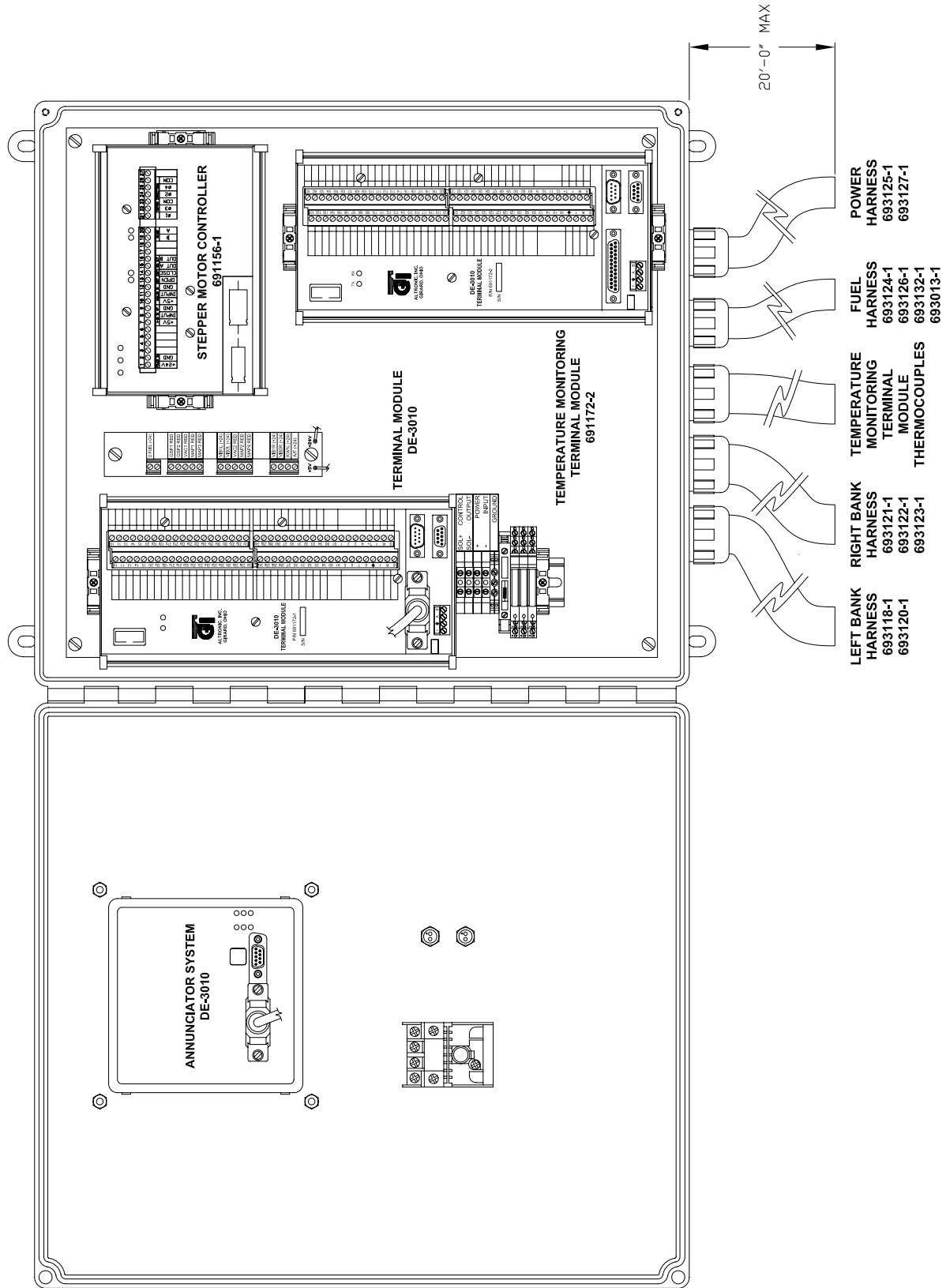
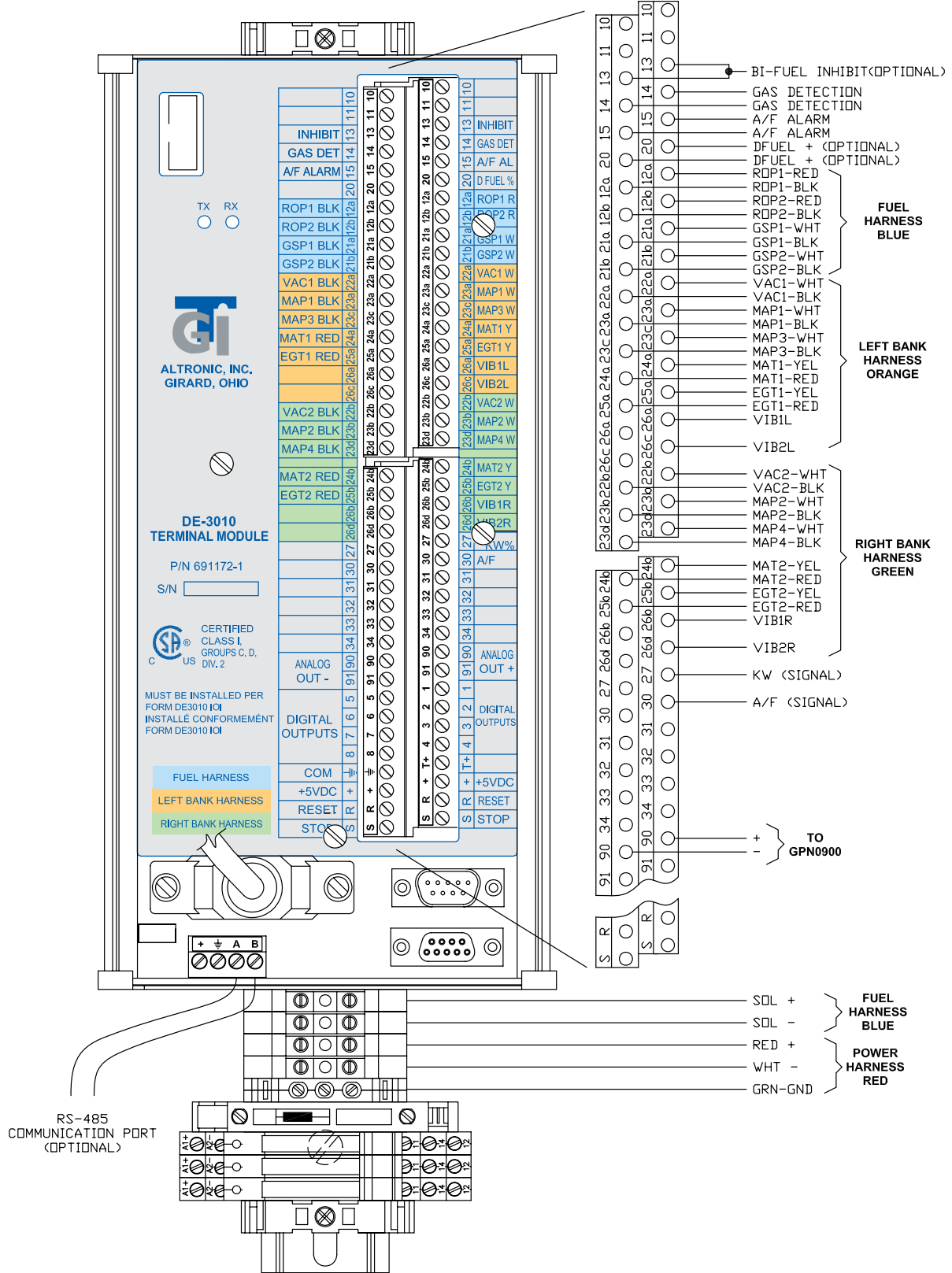

FIG. 10 – WIRING DIAGRAM – CUSTOMER CONNECTIONS – GPN2010V, GPN2212V, GPN2213V, GPN2214V



GTI V-ENGINE CONTROL SYSTEM

FIG. 11 – WIRING DIAGRAM – STEPPER MOTOR CONTROLLER – GPN2212V, GPN2214V

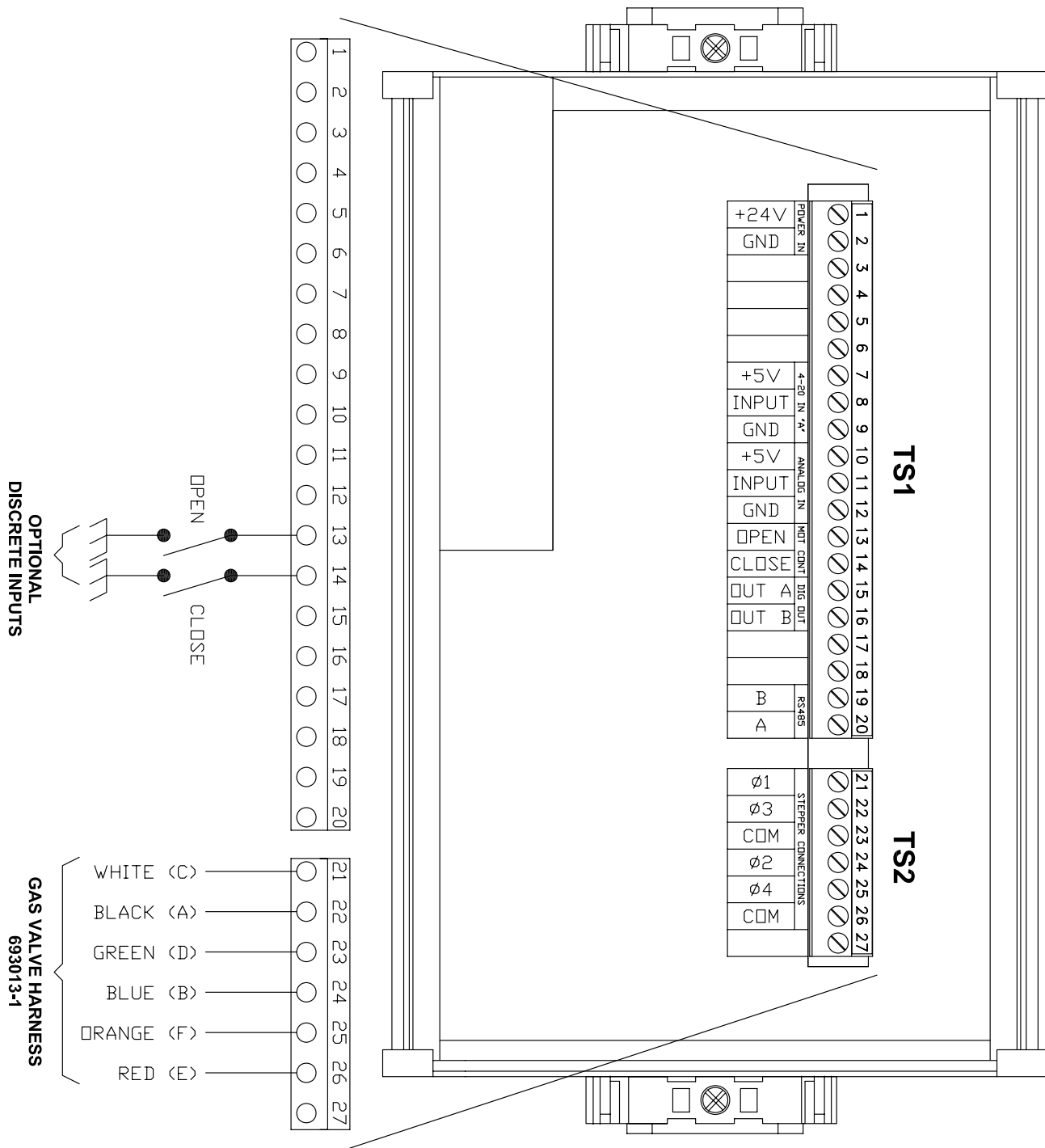
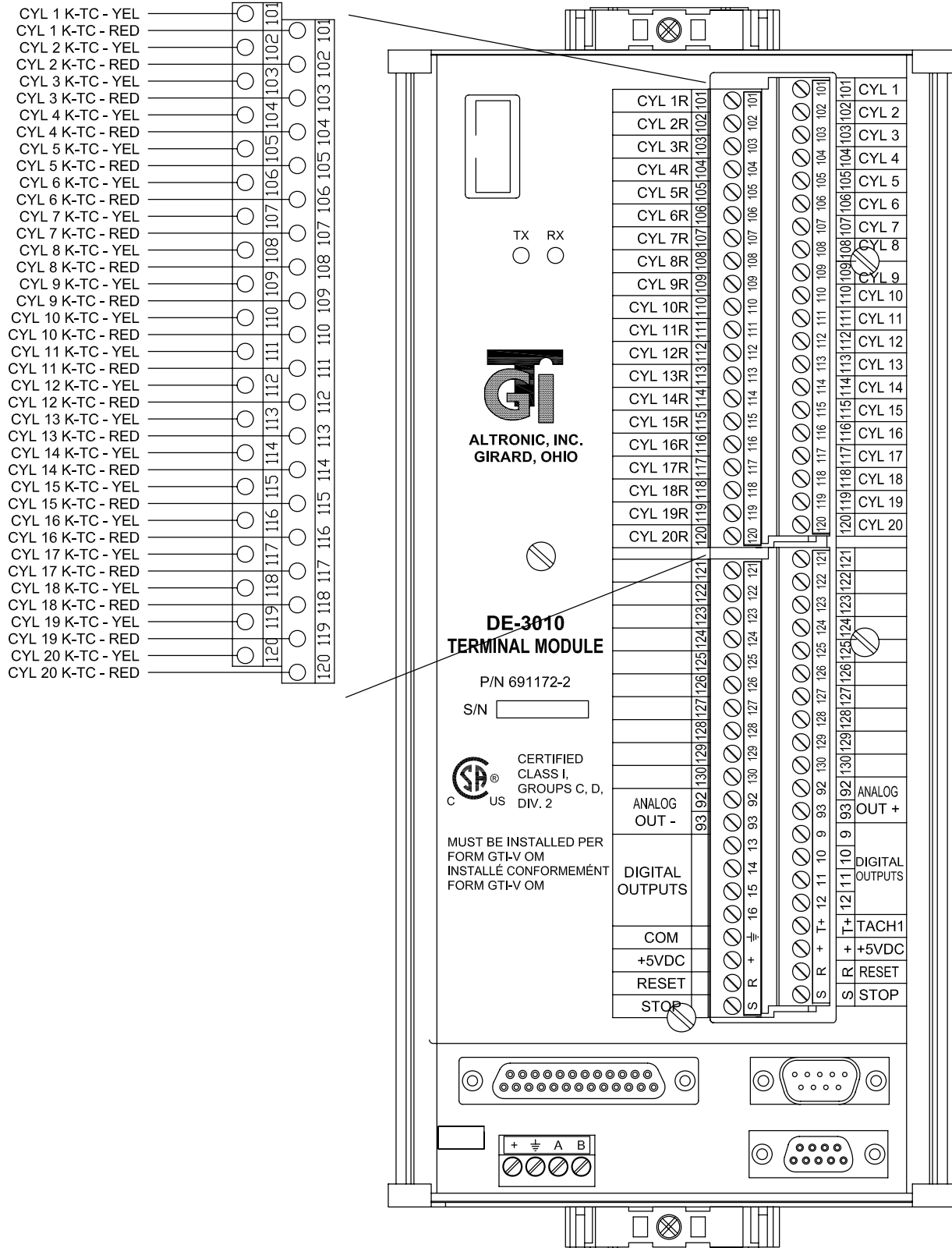

FIG. 12 – WIRING DIAGRAM – TEMPERATURE MONITORING TERMINAL – P/N 691172-2



GTI V-ENGINE CONTROL SYSTEM

FIG. 13 – WIRING DIAGRAM – SENSOR TERMINAL – GPN2010V, GPN2212V, GPN2213V, GPN2214V

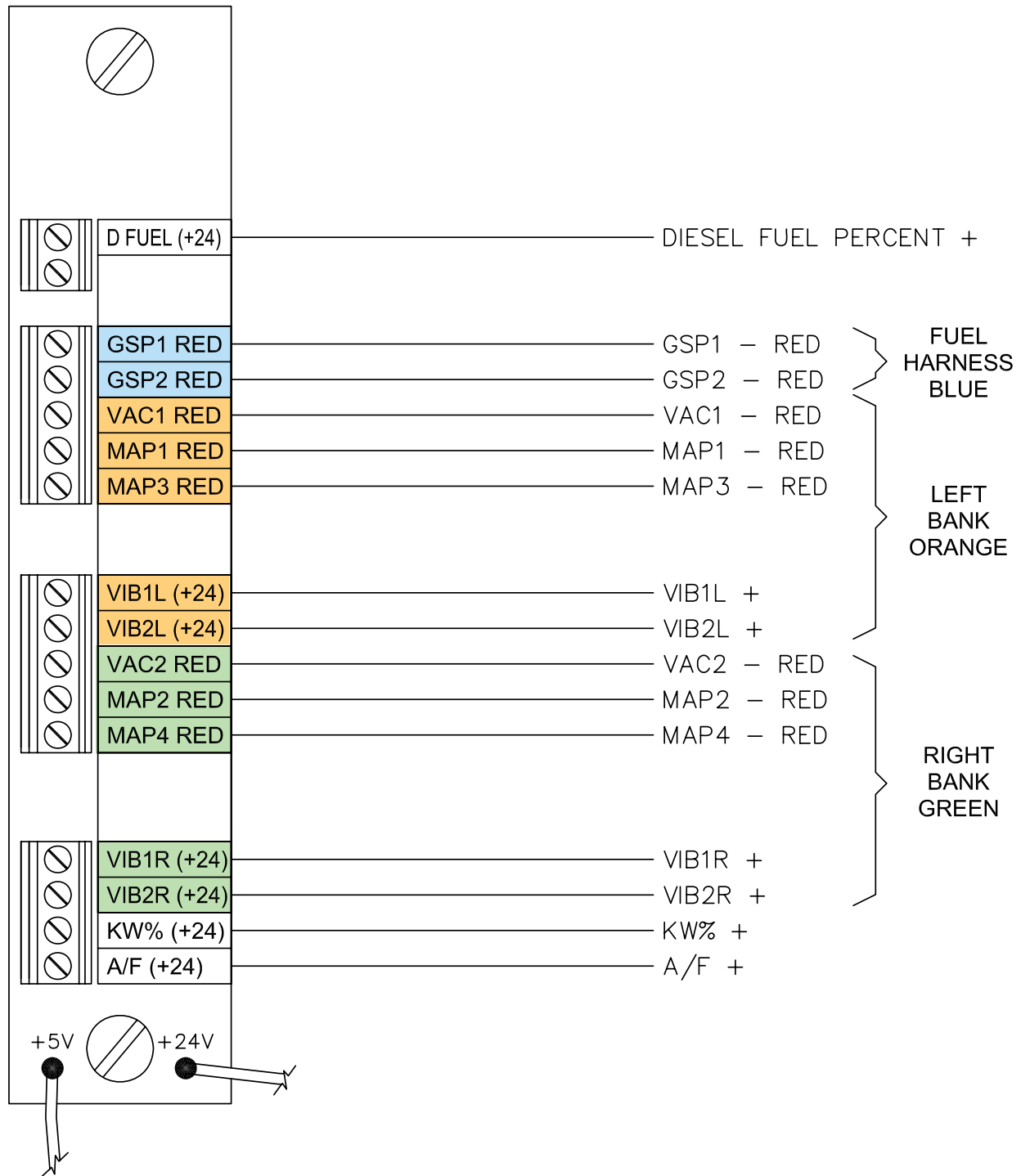
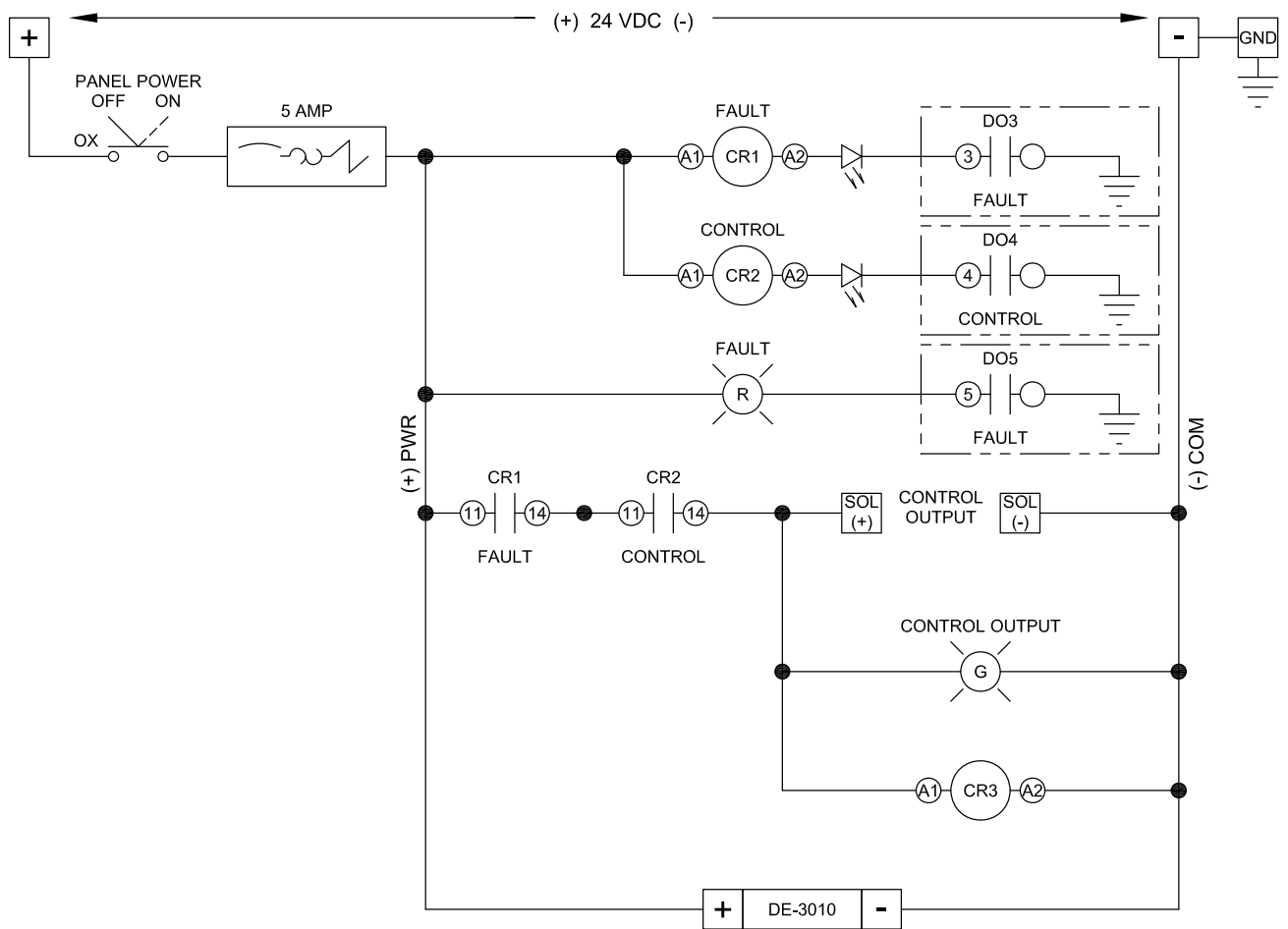

FIG. 14 – LADDER LOGIC



RELAY CR3 IS AN OPTIONAL CUSTOMER CONNECTION (TYPICALLY TO A PLC) TO DETECT GAS SUBSTITUTION

